

HOW TO INSTALL THE... CRADLE II

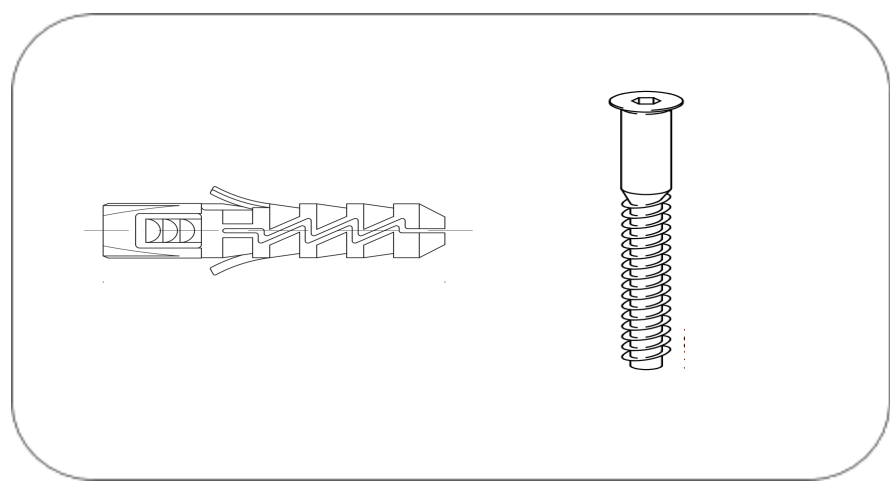

1

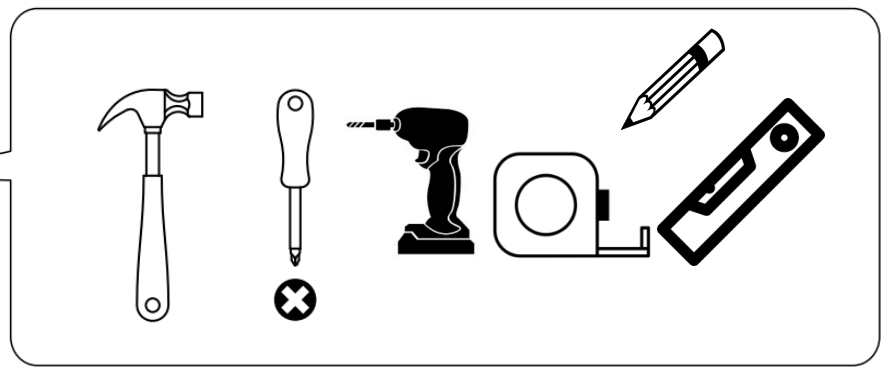
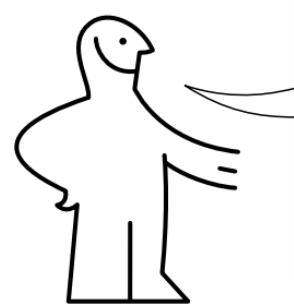
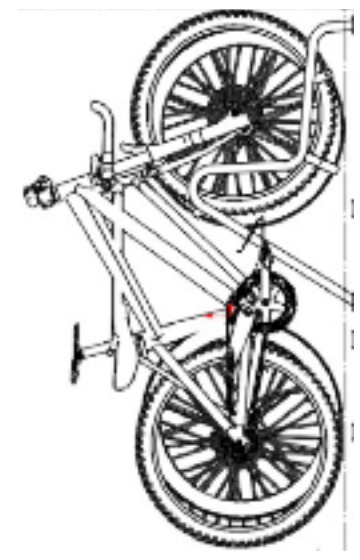
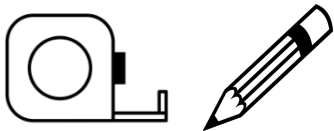
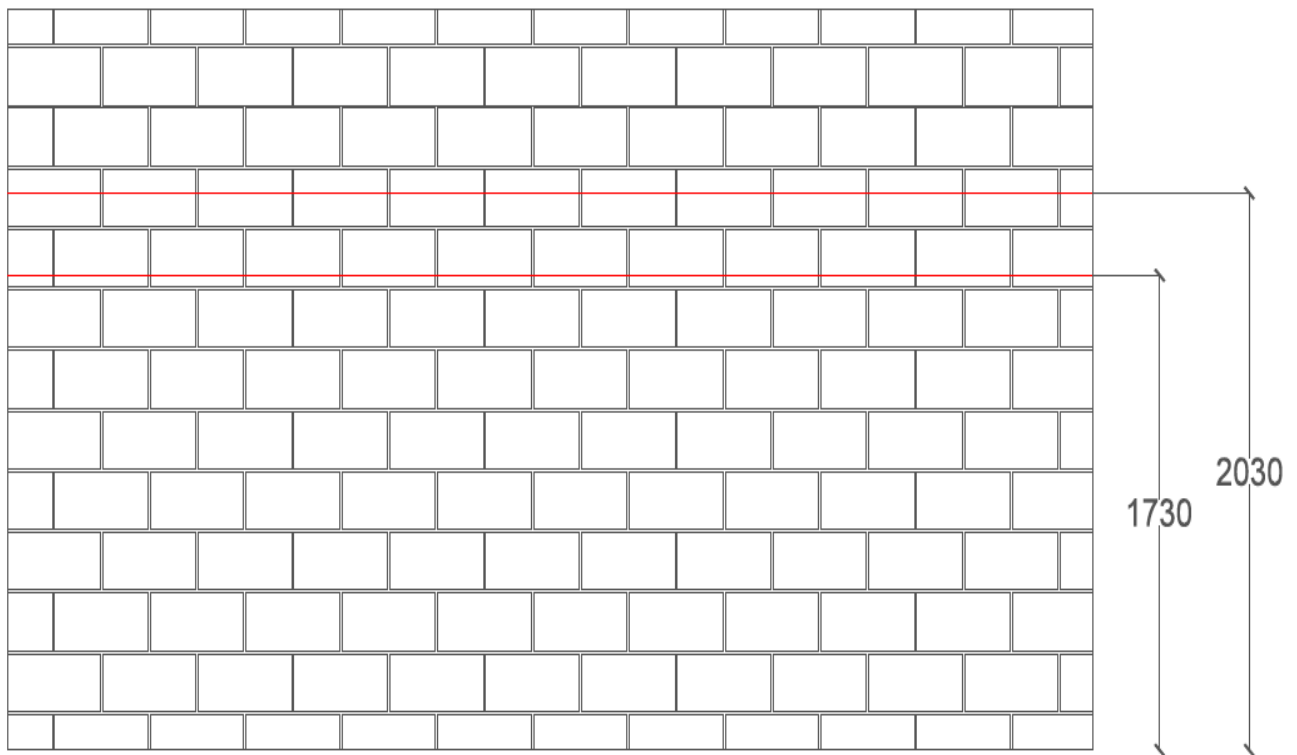

Using a chalk line or laser level, mark the heights of 2030mm & 1730mm on the wall.

2

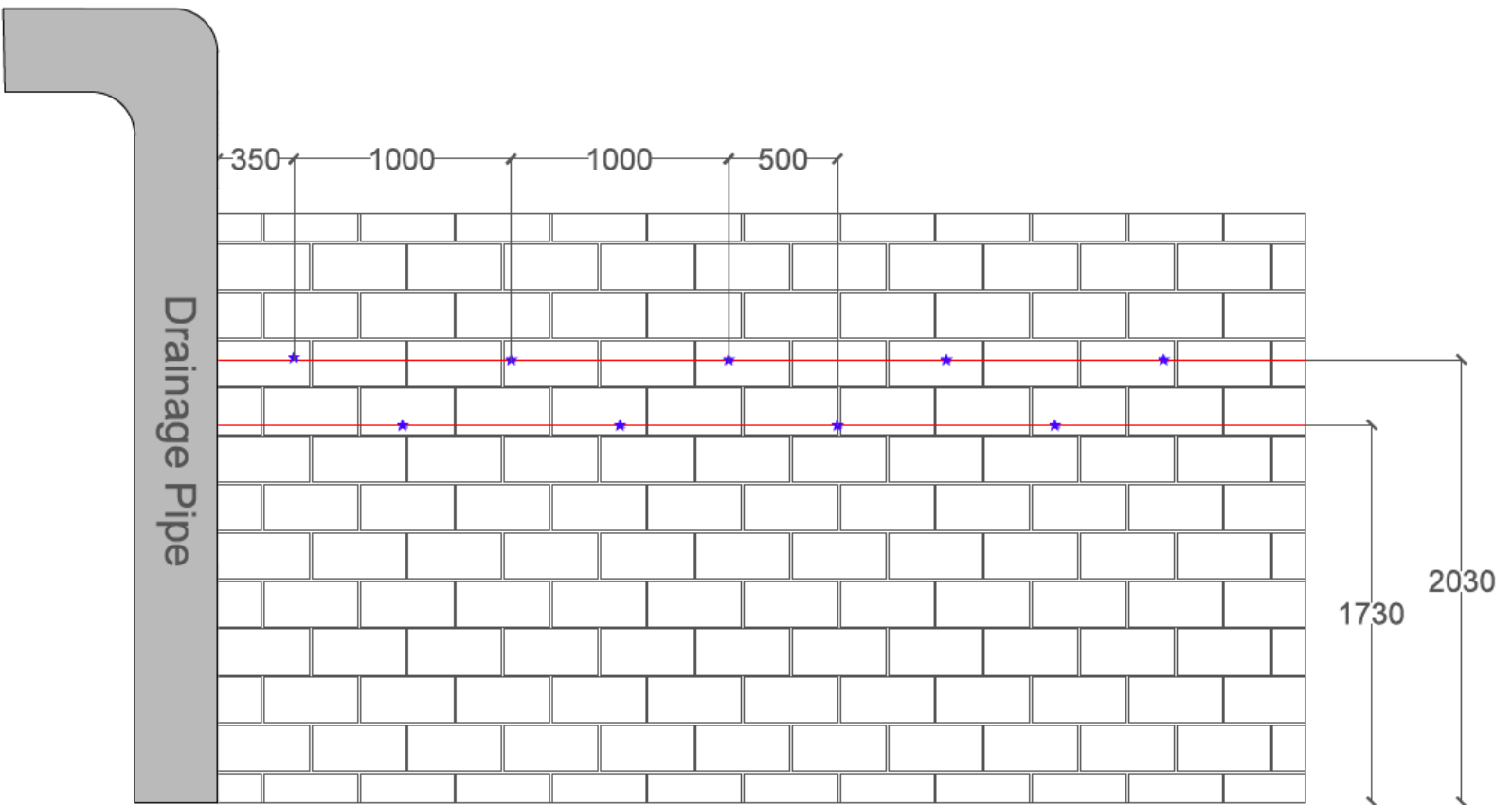

Using a pencil, mark the top fixing holes at 1000mm centres. If there is a nearby service, allow min. 350mm clearance from the service to the centre of the cradle. The cradles are installed at staggered heights.

3

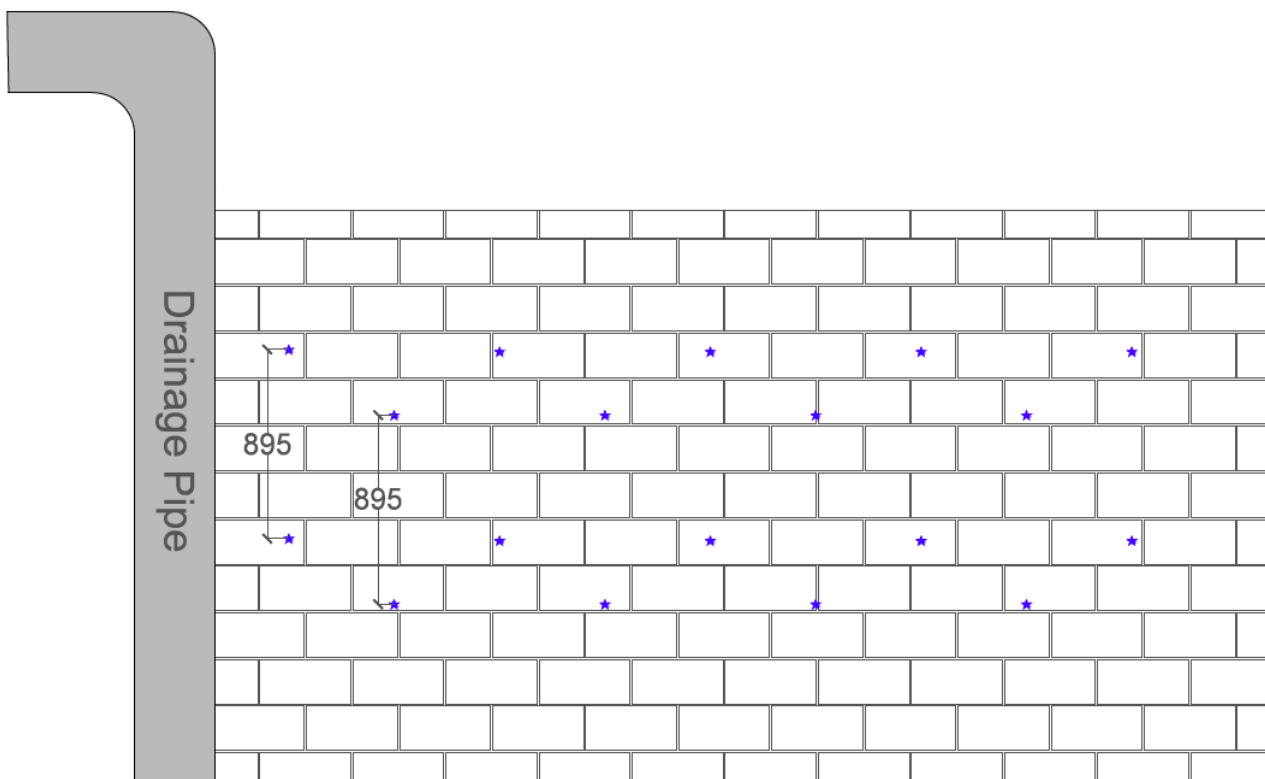

Using a laser level/Spirit level & pencil, mark the bottom fixing hole at a distance of 895mm from the top fixing hole

4

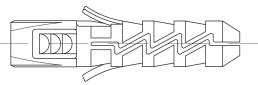
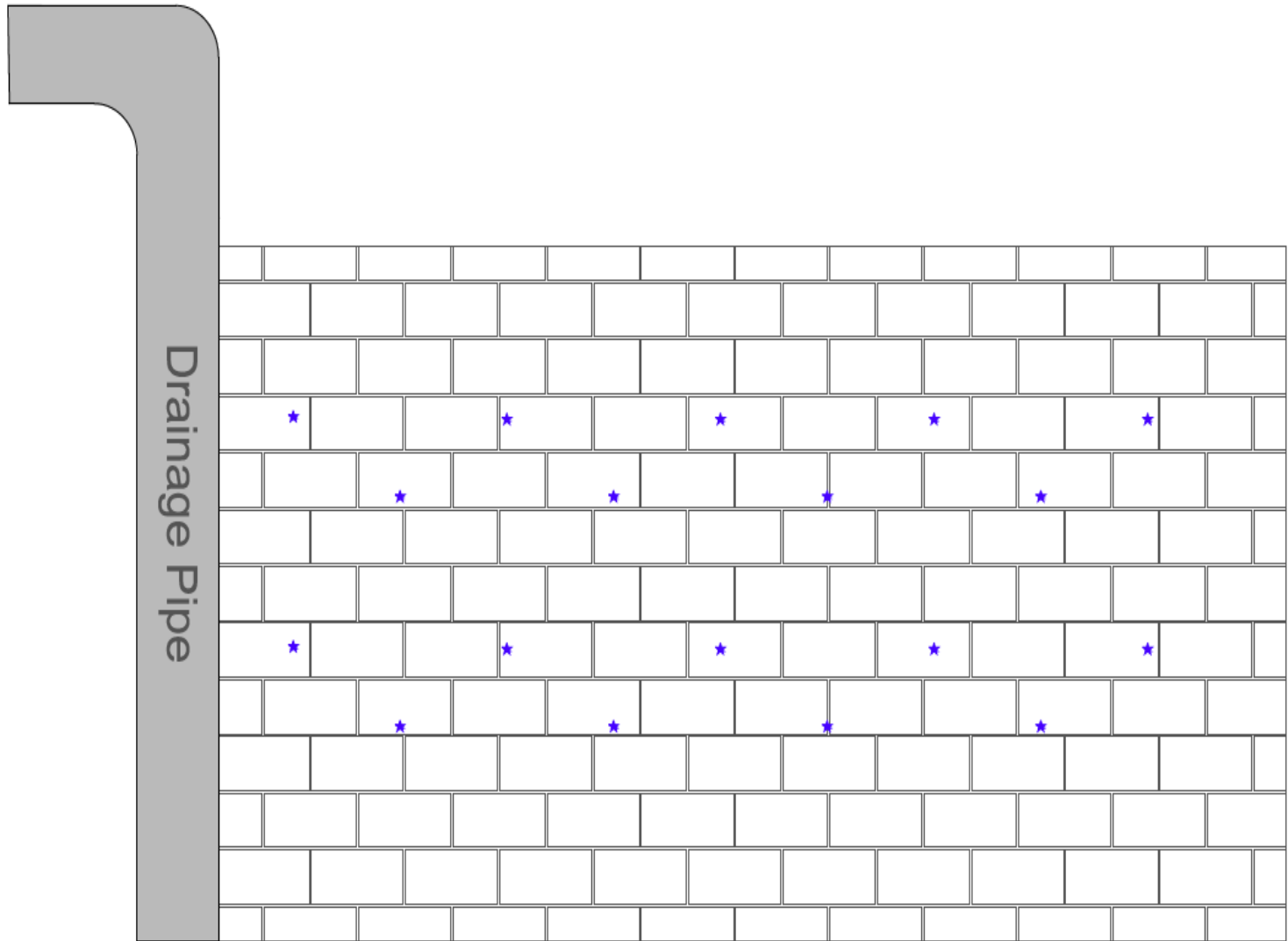

Drill the holes previously marked on the wall. If drilling blockwork or brick, use a 9mm SDS drill bit. If drilling concrete, use a 10mm SDS drill bit. Once you have drilled all the holes, hammer in the wall plugs.

5

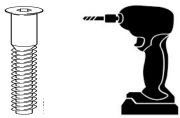
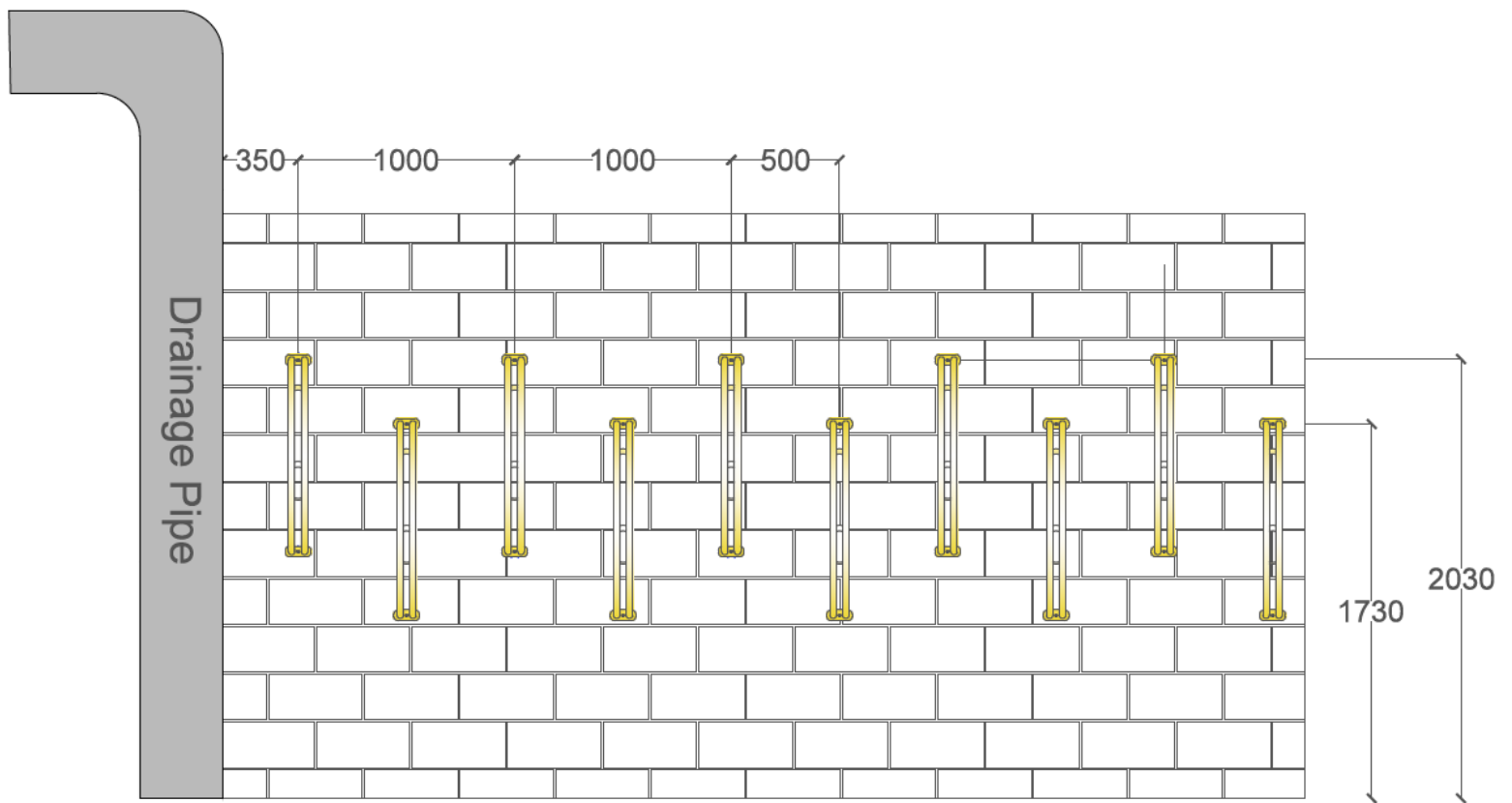

Secure the Cradle to the wall using tamper proof/ bugle screws through the top and bottom fixing holes. Check that the Cradle does not wobble or after it has been secured. The Cradle is now installed.